

环保物料

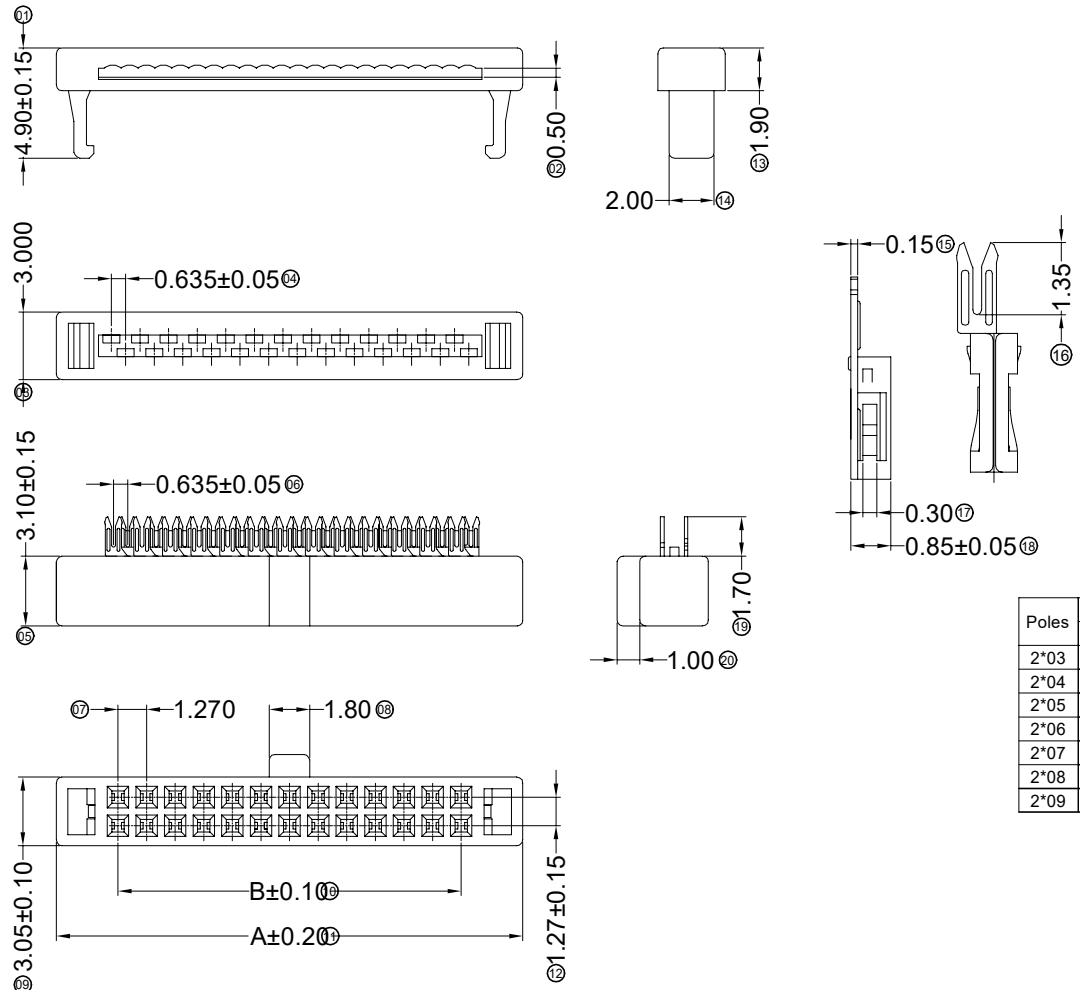

■ Specifications :

- Voltage rating: 250V AC / DC
- Current rating: 0.5A AC / DC
- Withstanding voltage: 500V AC/minute
- Temperature range: -25°C~+85°C
- Insulation resistance: ≥100MΩ
- Contact resistance: ≤30mΩ
- After environmental testing: ≤40mΩ

Poles	Dimensions (mm)		Poles	Dimensions (mm)		Poles	Dimensions (mm)	
	A	B		A	B		A	B
2*03	8.00	2.54	2*10	16.89	11.43	2*21	30.86	25.40
2*04	9.27	3.81	2*12	18.16	12.70	2*22	32.13	26.67
2*05	10.54	5.08	2*13	20.70	15.24	2*25	35.94	30.48
2*06	11.81	6.35	2*14	21.97	16.51	2*26	37.21	31.75
2*07	13.08	7.62	2*15	23.24	17.78	2*30	42.29	36.83
2*08	14.35	8.89	2*17	25.78	20.32	2*32	44.83	39.37
2*09	15.62	10.16	2*20	29.59	24.13			

				一般公差 GENERAL TOLERANCE				东莞市翰皓精密电子有限公司 Dongguan HanHao Precision Electronics Co.,Ltd				料号 PART NO A1271W-2xXX			
				.X ±0.3				核准 APPD				品名 TITLE 1.27 mm Crimp Style Connector			
				.XX ±0.2				审核 CHK				绘图 DR			
				.XXX ±0.1				日期 DATA				日期 DATE			
2011/05/14				修改图框格式				SUCCESS				刘艳			
旧版次 OLD REV				变更内容 DESCRIPTION				PROJECT				单位 UNIT			
新版次 NEW REV				审核 CHK				角法				比例 SCALE			
				核准 APPD				刘艳				图号 NUMBER			
								2007/05/03				版次 REV			
												A-069			
												B			

环保物料

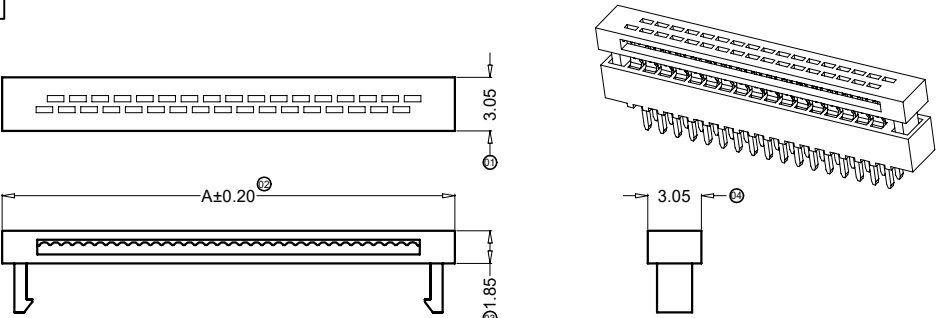

- Specifications :
- Voltage rating: 250V AC / DC
 - Current rating: 0.5A AC / DC
 - Withstanding voltage: 250V AC/minute
 - Temperature range: -25°C~+85°C
 - Insulation resistance: ≥100MΩ
 - Contact resistance: ≤30mΩ
 - After environmental testing: ≤40mΩ

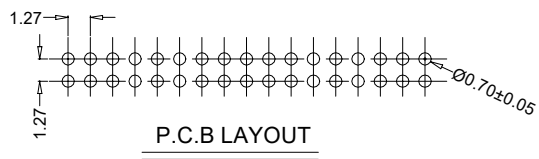
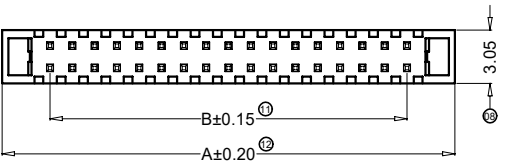
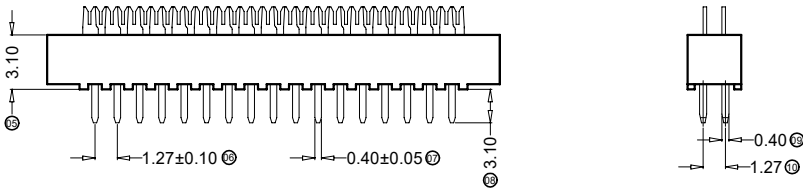

Poles	Dimensions(mm)		Poles	Dimensions(mm)	
	A	B		A	B
2*03	8.00	2.54	2*13	20.70	15.24
2*04	9.27	3.81	2*15	23.24	17.78
2*05	10.54	5.08	2*17	25.78	20.32
2*06	11.81	6.35	2*20	29.59	24.13
2*07	13.08	7.62	2*22	32.13	26.67
2*08	14.35	8.89	2*25	35.94	30.48
2*09	15.62	10.16	2*30	42.29	36.83
2*10	16.89	11.43	2*32	44.83	39.37

				一般公差 GENERAL TOLERANCE				东莞市翰皓精密电子有限公司 Dongguan HanHao Precision Electronics Co.,Ltd				料号 PART NO A1272W-2*XX			
				.X ±0.3 .XX ±0.2 .XXX ±0.1				核准 APPD 审核 CHK 绘图 DR 日期 DATA				品名 TITLE 1.27 mm Crimp Style Connectors			
2011/05/14	A	B	修改图框格式				SUCCESS				刘艳				
日期 DATE	旧版次 OLD REV	新版次 NEW REV	变更内容 DESCRIPTION				审核 CHK				核准 APPD				
				角法 PROJECT				2007/05/03				单位 UNIT MM			
												比例 SCALE 1/1			
												图号 NUMBER A-069			
												版次 REV B			

环保物料

- Specifications :
- Voltage rating: 250V AC / DC
 - Current rating: 1A AC / DC
 - Withstanding voltage: 500V AC/minute
 - Temperature range: -25°C~+85°C
 - Insulation resistance: ≥100MΩ
 - Contact resistance: ≤30mΩ
 - After environmental testing: ≤40mΩ
 - Material(Pin): Brass
 - Material(CAP): LCP UL94V-0 Halogen free

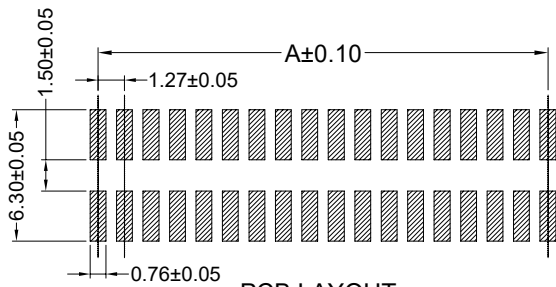
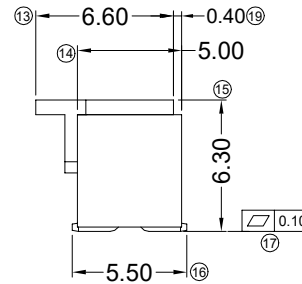
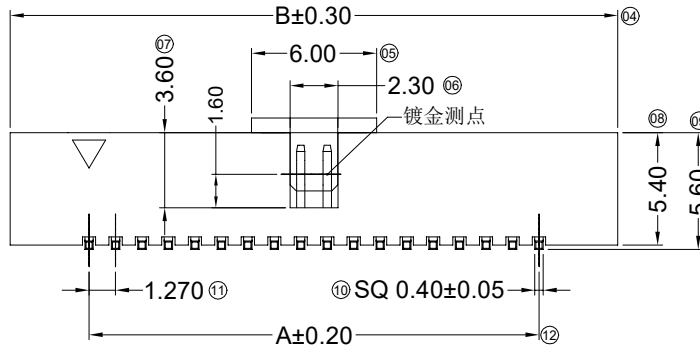
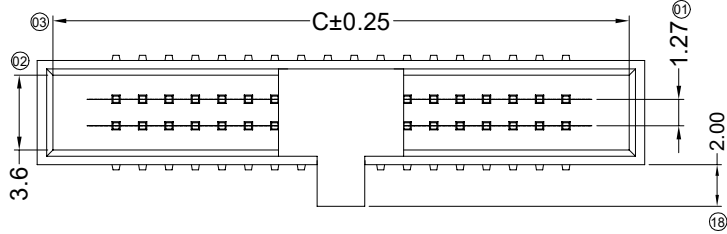

PCB LAYOUT

Poles	Dimensions (mm)		
	A	B	C
2*02	1.27	8.84	7.34
2*04	3.81	11.38	9.88
2*05	5.08	12.65	11.15
2*10	11.43	19.00	17.47
2*22	26.67	34.24	32.71

				一般公差 GENERAL TOLERANCE				东莞市翰皓精密电子有限公司 Dongguan HanHao Precision Electronics Co.,Ltd				料号 PART NO D1271W-2*XX			
				.X ±0.3 .XX ±0.2 .XXX ±0.1				核准 APPD 审核 CHK 绘图 DR 日期 DATA				品名 TITLE 1.27mm Box Header Connector			
2011/05/14	A	B	修改图框格式				SUCCESS				刘艳				
日期 DATE	旧版次 OLD REV	新版次 NEW REV	变更内容 DESCRIPTION				审核 CHK				核准 APPD				
				角法 PROJECT				2007/05/03				单位 UNIT MM			
												比例 SCALE 1/1			
												图号 NUMBER A-069			
												版次 REV B			

环保物料

Specifications :

- Voltage rating: 250V AC / DC
- Current rating: 1A AC / DC
- Withstanding voltage: 500V AC/minute
- Temperature range: -40°C~+105°C
- Insulation resistance: ≥100MΩ
- Contact resistance: ≤20mΩ
- After environmental testing: ≤40mΩ

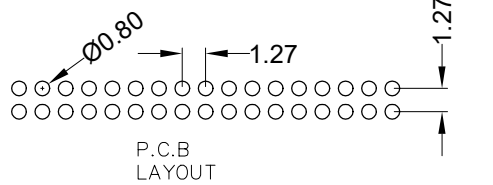
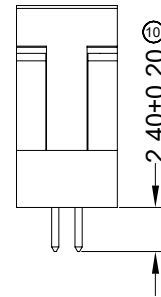
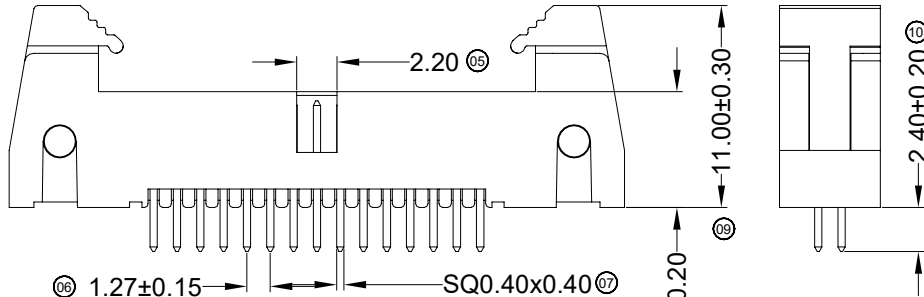
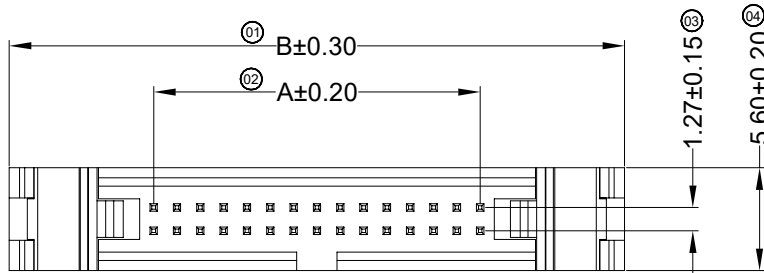

Poles	Dimensions (mm)	
	A	B
06	2.54	18.31
08	3.81	19.58
10	5.08	20.85
14	7.62	23.39
16	8.89	24.66
18	10.16	25.93
20	11.43	27.20
26	15.24	31.01
30	17.78	33.55
34	20.32	36.09
40	24.13	39.90
50	30.48	46.25
60	36.83	52.60
64	39.37	55.14
68	41.91	57.68

				一般公差 GENERAL TOLERANCE				东莞市翰皓精密电子有限公司 Dongguan HanHao Precision Electronics Co.,Ltd				料号 PART NO D1271W-2*XX			
				.X ±0.3 .XX ±0.2 .XXX ±0.1				核准 APPD 审核 CHK 绘图 DR 日期 DATA				品名 TITLE 1.27 mm Crimp Style Connectors			
2011/05/14	A	B	修改图框格式				SUCCESS				刘艳				
日期 DATE	旧版次 OLD REV	新版次 NEW REV	变更内容 DESCRIPTION				审核 CHK				2007/05/03				
				角法 PROJECT				单位 UNIT				比例 SCALE			
				MM				1/1				图号 NUMBER A-069			
												版次 REV B			

环保物料

■ Specifications :

- Voltage rating: 250V AC / DC
- Current rating: 0.5A AC / DC
- Withstanding voltage: 500V AC/minute
- Temperature range: -25°C~+85°C
- Insulation resistance: ≥100MΩ
- Contact resistance: ≤30mΩ
- After environmental testing: ≤40mΩ

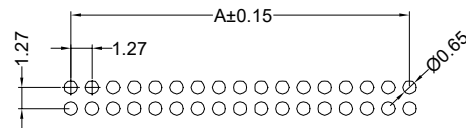
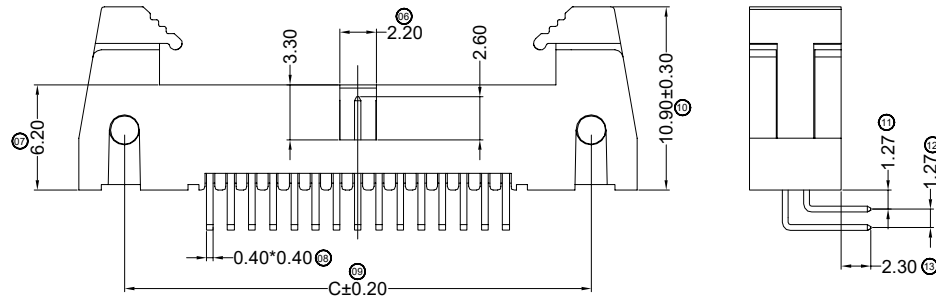
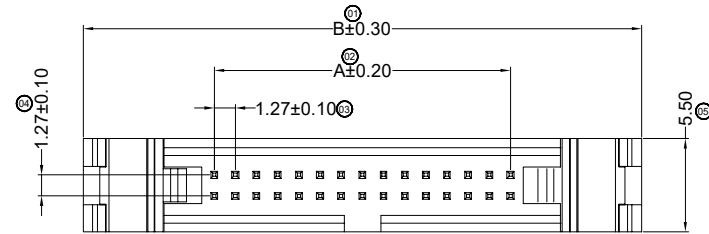

P.C.B Board Layout

Poles	Dimensions (mm)		
	A	B	C
06	2.54	18.31	12.81
08	3.81	19.58	14.08
10	5.08	20.85	15.35
14	7.62	23.39	17.89
16	8.89	24.66	19.16
18	10.16	25.93	20.43
20	11.43	27.20	21.70
26	15.24	31.01	25.51
30	17.78	33.55	28.05
34	20.32	36.09	30.59
40	24.13	39.90	34.40
50	30.48	46.25	40.75
60	36.83	52.60	47.10
64	39.37	55.14	49.64
68	41.91	57.68	52.18

				一般公差 GENERAL TOLERANCE				料号 PART NO D1271WR-2*XX						
				.X ±0.3				品名 TITLE						
				.XX ±0.2				1.27 mm Crimp Style Connector						
				.XXX ±0.1				核准 APPD 审核 CHK 绘图 DR 日期 DATA						
2011/05/14	A	B	修改图框格式					SUCCESS	刘艳	2007/05/03	单位 UNIT MM	比例 SCALE 1/1	图号 NUMBER A-069	版次 REV B
日期 DATE	旧版次 OLD REV	新版次 NEW REV	变更内容 DESCRIPTION	审核 CHK	核准 APPD	角法 PROJECT								

A

A

环保物料

■ Specifications :

- Voltage rating: 250V AC / DC
- Current rating: 1A AC / DC
- Withstanding voltage: 500V AC/minute
- Temperature range: -40°C~+105°C
- Insulation resistance: ≥100MΩ
- Contact resistance: ≤20mΩ
- After environmental testing: ≤40mΩ

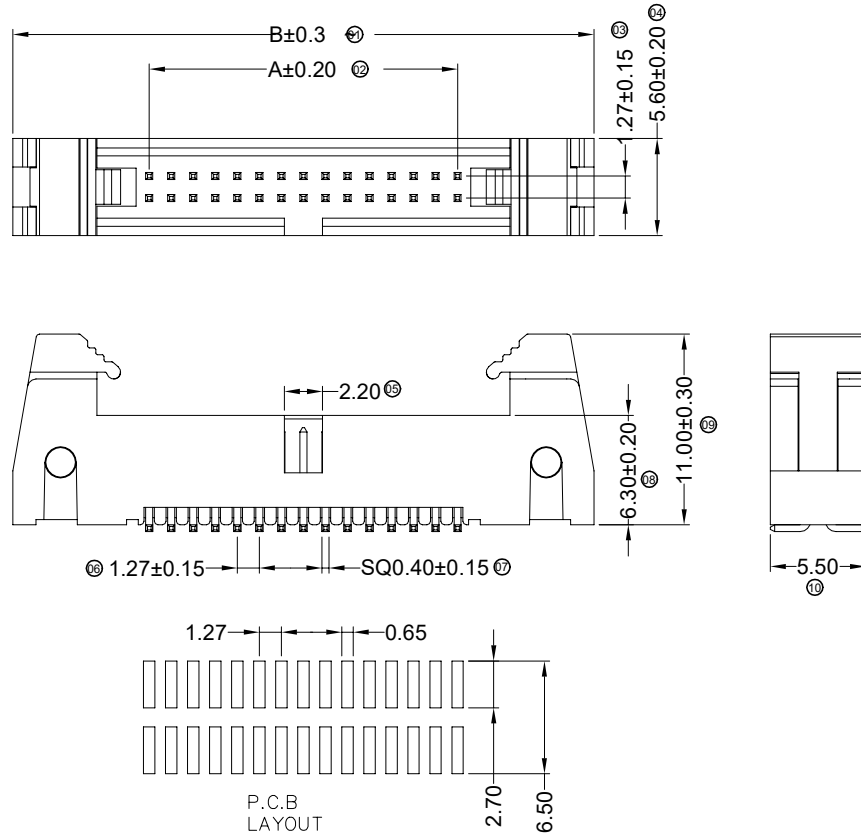

Poles	Dimensions (mm)		Poles	Dimensions (mm)	
	A	B		A	B
2*03	2.54	18.31	2*15	17.78	33.55
2*04	3.81	19.58	2*17	20.32	36.09
2*05	5.08	20.85	2*20	24.13	39.90
2*07	7.62	23.39	2*25	30.48	46.25
2*08	8.89	24.66	2*30	36.83	52.60
2*09	10.16	25.93	2*32	39.37	55.14
2*10	11.43	27.20	2*34	41.91	57.68
2*13	15.24	31.01			

				一般公差 GENERAL TOLERANCE				东莞市翰皓精密电子有限公司 Dongguan HanHao Precision Electronics Co.,Ltd				料号 PART NO D1271WS-2*XX			
				.X ±0.3 .XX ±0.2 .XXX ±0.1				核准 APPD 审核 CHK 绘图 DR 日期 DATA				品名 TITLE 1.27 mm Crimp Style Connectors			
2011/05/14	A	B	修改图框格式				SUCCESS 刘艳 2007/05/03				单位 UNIT 比例 SCALE 图号 NUMBER 版次 REV MM 1/1 A-069 B				
日期 DATE	旧版次 OLD REV	新版次 NEW REV	变更内容 DESCRIPTION				审核 CHK	核准 APPD	角法 PROJECT						

环保物料

- Specifications :
- Voltage rating: 250V AC / DC
 - Current rating: 1.0A AC / DC
 - Withstanding voltage: 300V AC/minute
 - Temperature range: -25°C~+85°C
 - Insulation resistance: ≥500MΩ
 - Contact resistance: ≤20mΩ
 - After environmental testing: ≤40mΩ
 - Material(PIN):Brass

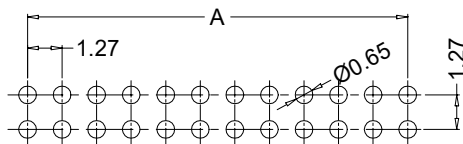
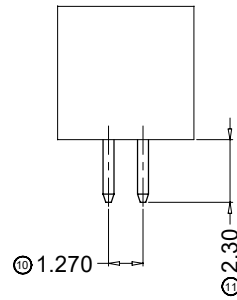
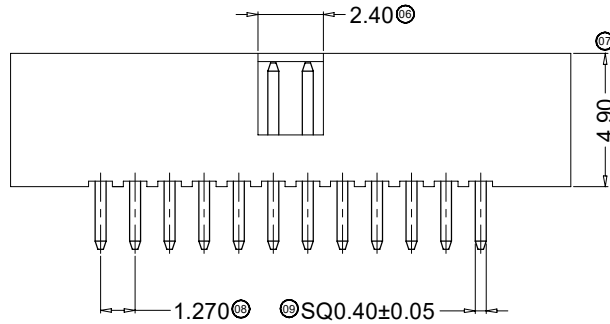
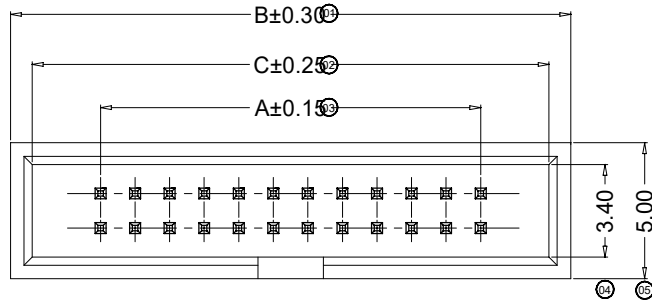

Recommended P.C.B Layout
General Tolerance±0.05

Poles	Dimensions (mm)			Poles	Dimensions (mm)		
	A	B	C		A	B	C
2*02	1.27	8.89	7.29	2*16	19.05	26.67	25.07
2*03	2.54	10.31	8.56	2*17	20.32	27.94	26.34
2*04	3.81	11.43	9.83	2*18	21.59	29.21	27.61
2*05	5.08	12.70	11.10	2*19	22.86	30.48	28.88
2*06	6.35	13.97	12.37	2*20	24.13	31.75	30.15
2*07	7.62	15.24	13.64	2*21	25.40	33.02	31.42
2*08	8.89	16.51	14.91	2*22	26.67	34.29	32.69
2*09	10.16	17.78	16.18	2*23	27.94	35.56	33.96
2*10	11.43	19.05	17.45	2*24	29.21	36.83	35.23
2*11	12.70	20.32	18.72	2*25	30.48	38.10	36.50
2*12	13.97	21.59	19.99	2*26	31.75	39.37	37.77
2*13	15.24	22.86	21.26	2*27	33.02	40.64	39.04
2*14	16.51	24.13	22.53	2*28	34.29	41.91	40.31
2*15	17.78	25.40	23.80	2*29	35.56	43.18	41.58

				一般公差 GENERAL TOLERANCE .X ±0.3 .XX ±0.2 .XXX ±0.1				料号 PART NO D1272W-2*XX			
				东莞市翰皓精密电子有限公司 Dongguan HanHao Precision Electronics Co.,Ltd				品名 TITLE 1.27 mm Crimp Style Connector			
2011/05/14	A	B	修改图框格式	核准 APPD	审核 CHK	绘图 DR	日期 DATA	单位 UNIT	比例 SCALE	图号 NUMBER	版次 REV
日期 DATE	旧版次 OLD REV	新版次 NEW REV	变更内容 DESCRIPTION	审核 CHK	核准 APPD	角法 PROJECT	SUCCESS	刘艳	2007/05/03	A-069	B

环保物料

■ Specifications :

- Voltage rating: 250V AC / DC
- Current rating: 0.5A AC / DC
- Withstanding voltage: 500V AC/minute
- Temperature range: -25°C~+85°C
- Insulation resistance: ≥100MΩ
- Contact resistance: ≤30mΩ
- After environmental testing: ≤40mΩ

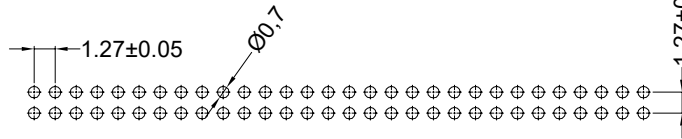
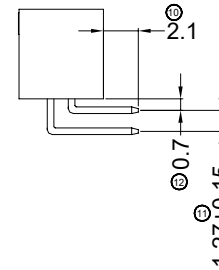
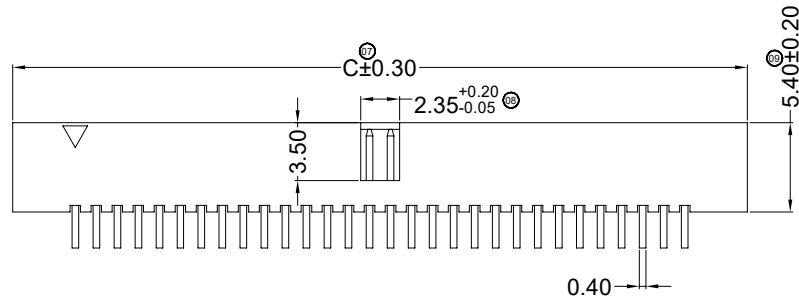
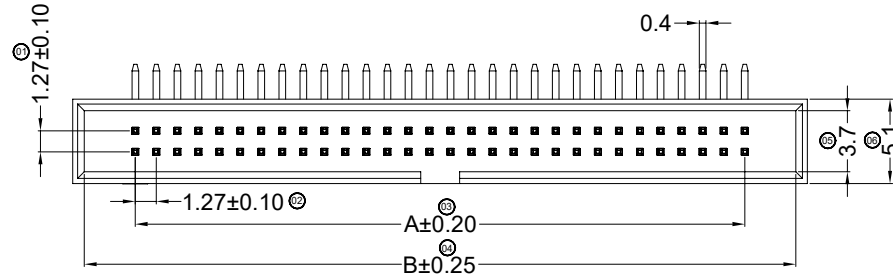

Recommended PCB Layout

Poles	Dimensions (mm)			Poles	Dimensions (mm)		
	A	B	C		A	B	C
2*02	1.27	7.43	8.84	2*11	12.70	18.87	20.27
2*03	2.54	8.70	10.11	2*12	13.97	20.14	21.54
2*04	3.81	9.98	11.38	2*13	15.24	21.41	22.81
2*05	5.08	11.25	12.65	2*15	17.78	23.95	25.35
2*06	6.35	12.52	13.92	2*17	20.32	26.49	27.89
2*07	7.62	13.79	15.19	2*20	24.13	30.30	31.70
2*08	8.89	15.06	16.46	2*25	30.48	36.65	38.05
2*09	10.16	16.33	17.73	2*30	36.83	43.00	44.40
2*10	11.43	17.60	19.00				

				一般公差 GENERAL TOLERANCE				料号 PART NO D1272WR-2*XX			
				.X ±0.3				品名 TITLE 1.27 mm Crimp Style Connector			
				.XX ±0.2				核准 APPD 审核 CHK 绘图 DR 日期 DATA			
				.XXX ±0.1				SUCCESS 刘艳 2007/05/03			
2011/05/14	A	B	修改图框格式	审核 CHK	核准 APPD	角法 PROJECT	单位 UNIT MM	比例 SCALE 1/1	图号 NUMBER A-069	版次 REV B	
日期 DATE	旧版次 OLD REV	新版次 NEW REV	变更内容 DESCRIPTION								

东莞市翰皓精密电子有限公司
Dongguan HanHao Precision Electronics Co.,Ltd